

FCC RADIO TEST REPORT

FCC ID: 2AT2W-MHDENET

Product: MHD TUNING Flasher
Trade Name: N/A
Model Name: MHD ENET
Serial Model: N/A
Report No.: UNIA19070903FR-01

Prepared for

MHD Tuning UG

Amelhauser Straße, 27 26197 Grossenkneten Germany

Prepared by

Shenzhen United Testing Technology Co., Ltd.

2F, Annex Bldg, Jiahuangyuan Tech Park, #365 Baotian 1 Rd, Tiegang
Community, Xixiang Str, Bao'an District, Shenzhen, China

TEST RESULT CERTIFICATION

Applicant's name.....: MHD Tuning UG

Address.....: Amelhauser Straße, 27 26197 Grossenkneten Germany

Manufacture's Name.....: Autosvs Technology Co., Ltd.

Address.....: Rm A 15/F Bldg A NO.1 World Plaza HongLi West Road LianHua Street FuTian District ShenZhen 518034 Guangdong China

Product description

Product name.....: MHD TUNING Flasher

Trade Mark.....: N/A

Model and/or type reference ..: MHD ENET

Standards.....: FCC Rules and Regulations Part 15 Subpart C Section 15.247
ANSI C63.10: 2013

This device described above has been tested by Shenzhen United Testing Technology Co., Ltd., and the test results show that the equipment under test (EUT) is in compliance with the FCC requirements. And it is applicable only to the tested sample identified in the report.

This report shall not be reproduced except in full, without the written approval of UNI, this document may be altered or revised by Shenzhen United Testing Technology Co., Ltd., personnel only, and shall be noted in the revision of the document.

Date of Test.....:

Date (s) of performance of tests.....: Jul. 09, 2019 ~Jul. 19, 2019

Date of Issue.....: Jul. 19, 2019

Test Result.....: Pass

Prepared by:

Kahn Yang

Kahn yang/Editor

Reviewer:

Sherwin Qian

Sherwin Qian/Supervisor

Approved & Authorized Signer:

Liuze

Liuze/Manager

Table of Contents

Page

1. TEST SUMMARY.....	5
2. GENERAL INFORMATION.....	6
2.1 GENERAL DESCRIPTION OF EUT.....	6
2.2 Carrier Frequency of Channels.....	7
2.3 Operation of EUT during testing.....	7
2.4 DESCRIPTION OF TEST SETUP.....	7
2.5 MEASUREMENT INSTRUMENTS LIST.....	8
3. CONDUCTED EMISSIONS TEST.....	9
3.1 Conducted Power Line Emission Limit.....	9
3.2 Test Setup.....	9
3.3 Test Procedure.....	9
3.4 Test Result.....	9
4 RADIATED EMISSION TEST.....	10
4.1 Radiation Limit.....	10
4.2 Test Setup.....	10
4.3 Test Procedure.....	11
4.4 Test Result.....	11
5 BAND EDGE.....	23
5.1 Limits.....	23
5.2 Test Procedure.....	23
5.3 Test Result.....	23
6 OCCUPIED BANDWIDTH MEASUREMENT.....	29
6.1 Test Limit.....	29
6.2 Test Procedure.....	29
6.3 Measurement Equipment Used.....	29
6.4 Test Result.....	29
7 POWER SPECTRAL DENSITY TEST.....	36
7.1 Test Limit.....	36
7.2 Test Procedure.....	36
7.3 Measurement Equipment Used.....	36
7.4 Test Result.....	36
8 PEAK OUTPUT POWER TEST.....	43
8.1 Test Limit.....	43
8.2 Test Procedure.....	43
8.3 Measurement Equipment Used.....	43

Table of Contents

Page

8.4 Test Result.....	43
9 OUT OF BAND EMISSIONS TEST.....	44
9.1 Test Limit.....	44
9.2 Test Procedure.....	44
9.3 Test Setup.....	44
9.4 Test Result.....	44
10 ANTENNA REQUIREMENT.....	48
11 PHOTOGRAPH OF TEST.....	49
11.1 Radiated Emission.....	49

DRAFT

1. TEST SUMMARY

TEST PROCEDURES AND RESULTS

DESCRIPTION OF TEST	RESULT	
CONDUCTED EMISSIONS TEST	COMPLIANT	FCC Part 15.207
RADIATED EMISSION TEST	COMPLIANT	FCC Part 15.209(a)
BAND EDGE	COMPLIANT	FCC Part 15.247(d)
OCCUPIED BANDWIDTH MEASUREMENT	COMPLIANT	FCC Part 15.247(a)(2)
POWER SPECTRAL DENSITY	COMPLIANT	FCC Part 15.247(e)
PEAK OUTPUT POWER	COMPLIANT	FCC Part 15.247(b)
OUT OF BAND EMISSIONS	COMPLIANT	FCC Part 15.247(d)
ANTENNA REQUIREMENT	COMPLIANT	FCC Part 15.203

TEST FACILITY

Test Firm : Shenzhen United Testing Technology Co., Ltd.
 Address : 2F, Annex Bldg, Jiahuangyuan Tech Park, #365 Baotian 1 Rd, Tiegang Community, Xixiang Str, Bao'an District, Shenzhen, China

The testing quality ability of our laboratory meet with "Quality Law of People's Republic of China" Clause 19. The testing quality system of our laboratory meets with ISO/IEC-17025 requirements, which is approved by CNAS. This approval result is accepted by MRA of APLAC.

Our test facility is recognized, certified, or accredited by the following organizations:

CNAS-LAB Code: L6494

The EMC Laboratory has been assessed and in compliance with CNAS-CL01 accreditation criteria for testing Laboratories (identical to ISO/IEC 17025:2017 General Requirements) for the Competence of testing Laboratories.

Designation Number: CN1227

Test Firm Registration Number: 674885

The EMC Laboratory has been registered and fully described in a report filed with the (FCC) Federal Communications commission. The acceptance letter from the FCC is maintained in our files.

MEASUREMENT UNCERTAINTY

Measurement Uncertainty	
Conducted Emission Expanded Uncertainty	= 2.23dB, k=2
Radiated emission expanded uncertainty(9kHz-30MHz)	= 3.08dB, k=2
Radiated emission expanded uncertainty(30MHz-1000MHz)	= 4.42dB, k=2
Radiated emission expanded uncertainty(Above 1GHz)	= 4.06dB, k=2

2. GENERAL INFORMATION

2.1 GENERAL DESCRIPTION OF EUT

Equipment	MHD TUNING Flasher
Trade Mark	N/A
Model Name	MHD ENET
Serial No.	N/A
Model Difference	N/A
FCC ID	2AT2W-MHDENET
Antenna Type	Internal antenna
Antenna Gain	1dBi
Frequency Range	802.11b/g/n20: 2412~2462 MHz
Number of Channels	802.11b/g/n20: 11CH
Modulation Type	CCK, OFDM, DBPSK, DAPSK
Battery	N/A
Power Source	DC 12V from adapter

2.2 Carrier Frequency of Channels

Channel List for 802.11b/g/n(20MHz)							
Channel	Frequency (MHz)	Channel	Frequency (MHz)	Channel	Frequency (MHz)	Channel	Frequency (MHz)
01	2412	04	2427	07	2442	10	2457
02	2417	05	2432	08	2447	11	2462
03	2422	06	2437	09	2452		

2.3 Operation of EUT during testing

Operating Mode

The mode is used: Transmitting mode for 802.11b/g/n(20MHz)

Low Channel: 2412MHz

Middle Channel: 2437MHz

High Channel: 2462MHz

2.4 DESCRIPTION OF TEST SETUP

Operation of EUT during Conducted testing:

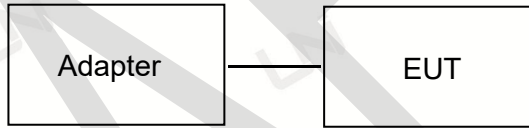

Operation of EUT during Radiation and Above 1GHz Radiation testing:



Table for auxiliary equipment:

Equipment Description	Manufacturer	Model	Calibration Due Date
N/A	N/A	N/A	N/A

2.5 MEASUREMENT INSTRUMENTS LIST

Item	Equipment	Manufacturer	Model No.	Serial No.	Calibrated until
CONDUCTED EMISSIONS TEST					
1	AMN	Schwarzbeck	NNLK8121	8121370	2019.9.9
2	AMN	ETS	3810/2	00020199	2019.9.9
3	EMI TEST RECEIVER	Rohde&Schwarz	ESCI	101210	2019.9.9
4	AAN	TESEQ	T8-Cat6	38888	2019.9.9
RADIATED EMISSION TEST					
1	Horn Antenna	Sunol	DRH-118	A101415	2019.9.29
2	BicoNILog Antenna	Sunol	JB1 Antenna	A090215	2019.9.29
3	PREAMP	HP	8449B	3008A00160	2019.9.9
4	PREAMP	HP	8447D	2944A07999	2019.9.9
5	EMI TEST RECEIVER	Rohde&Schwarz	ESR3	101891	2019.9.9
6	VECTOR Signal Generator	Rohde&Schwarz	SMU200A	101521	2019.9.28
7	Signal Generator	Agilent	E4421B	MY4335105	2019.9.28
8	MXA Signal Analyzer	Agilent	N9020A	MY50510140	2019.9.28
9	MXA Signal Analyzer	Agilent	N9020A	MY51110104	2019.9.9
10	ANT Tower&Turn table Controller	Champro	EM 1000	60764	2019.9.28
11	Anechoic Chamber	Taihe Maorui	9m*6m*6m	966A0001	2019.9.9
12	Shielding Room	Taihe Maorui	6.4m*4m*3m	643A0001	2019.9.9
13	RF Power sensor	DARE	RPR3006W	15I00041SNO88	2020.3.14
14	RF Power sensor	DARE	RPR3006W	15I00041SNO89	2019.3.14
15	RF power divider	Anritsu	K241B	992289	2019.9.28
16	Wideband radio communication tester	Rohde&Schwarz	CMW500	154987	2019.9.28
17	Biconical antenna	Schwarzbeck	VHA 9103	91032360	2019.9.8
18	Biconical antenna	Schwarzbeck	VHA 9103	91032361	2019.9.8
19	Broadband Hybrid Antennas	Schwarzbeck	VULB9163	VULB9163#958	2019.9.8
20	Horn Antenna	Schwarzbeck	BBHA9120D	9120D-1680	2020.1.12
21	Active Receive Loop Antenna	Schwarzbeck	FMZB 1919B	00023	2019.9.8
22	Horn Antenna	Schwarzbeck	BBHA 9170	BBHA9170651	2020.03.14
23	Microwave Broadband Preamplifier	Schwarzbeck	BBV 9721	100472	2019.9.8
24	Active Loop Antenna	Com-Power	AL-130R	10160009	2020.05.10
25	Power Meter	KEYSIGHT	N1911A	MY50520168	2020.05.10
26	Frequency Meter	VICTOR	VC2000	997406086	2020.05.10
27	DC Power Source	HYELEC	HY5020E	055161818	2020.05.10

3. CONDUCTED EMISSIONS TEST

3.1 Conducted Power Line Emission Limit

For unintentional device, according to § 15.107(a) Line Conducted Emission Limits is as following

Frequency (MHz)	Maximum RF Line Voltage(dBμV)			
	CLASS A		CLASS B	
	Q.P.	Ave.	Q.P.	Ave.
0.15~0.50	79	66	66~56*	56~46*
0.50~5.00	73	60	56	46
5.00~30.0	73	60	60	50

* Decreasing linearly with the logarithm of the frequency

For intentional device, according to §15.207(a) Line Conducted Emission Limit is same as above table.

3.2 Test Setup

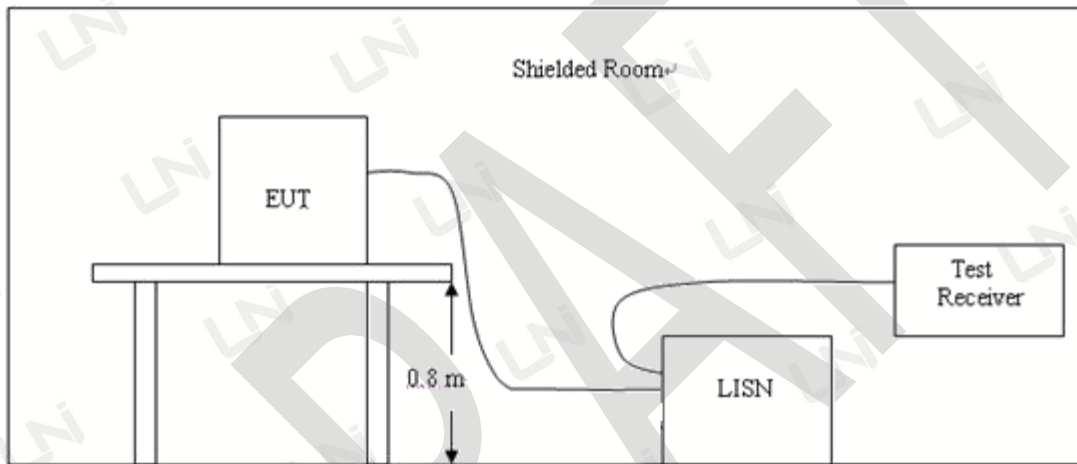

3.3 Test Procedure

- 1, The equipment was set up as per the test configuration to simulate typical actual usage per the user's manual. A wooden table with a height of 0.8 meters is used and is placed on the ground plane as per ANSI C63.10.
- 2, Support equipment, if needed, was placed as per ANSI C63.10.
- 3, All I/O cables were positioned to simulate typical actual usage as per ANSI C63.10.
- 4, If a EUT received DC power from the USB Port of Notebook PC, the PC's adapter received AC120V/60Hz power through a Line Impedance Stabilization Network (LISN) which supplied power source and was grounded to the ground plane.
- 5, All support equipments received AC power from a second LISN, if any.
- 6, The EUT test program was started. Emissions were measured on each current carrying line of the EUT using a spectrum Analyzer / Receiver connected to the LISN powering the EUT. The LISN has two monitoring points: Line 1 (Hot Side) and Line 2 (Neutral Side). Two scans were taken: one with Line 1 connected to Analyzer / Receiver and Line 2 connected to a 50 ohm load; the second scan had Line 1 connected to a 50 ohm load and Line 2 connected to the Analyzer / Receiver.
- 7, Analyzer / Receiver scanned from 150 KHz to 30MHz for emissions in each of the test modes.

3.4 Test Result

N/A

Remark:

The power supply used by the prototype is DC12V power supply, no test conduction

4 RADIATED EMISSION TEST

4.1 Radiation Limit

For unintentional device, according to § 15.109(a), except for Class A digital devices, the field strength of radiated emissions from unintentional radiators at a distance of 3 meters shall not exceed the following values:

Frequency (MHz)	Distance (Meters)	Radiated (dB μ V/m)	Radiated (μ V/m)
30-88	3	40	100
88-216	3	43.5	150
216-960	3	46	200
Above 960	3	54	500

For intentional device, according to § 15.209(a), the general requirement of field strength of radiated emissions from intentional radiators at a distance of 3 meters shall not exceed the above table.

4.2 Test Setup

1. Radiated Emission Test-Up Frequency Below 30MHz

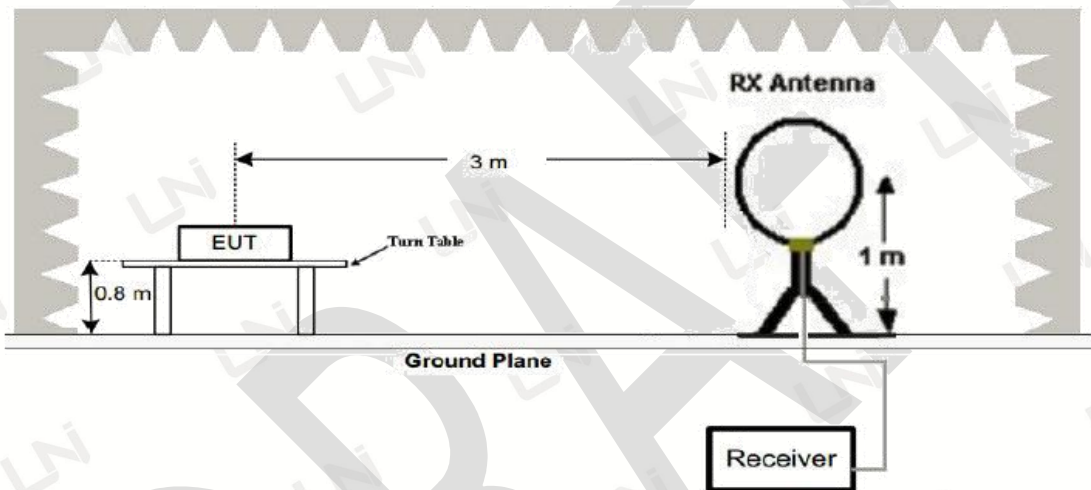

2. Radiated Emission Test-Up Frequency 30MHz~1GHz

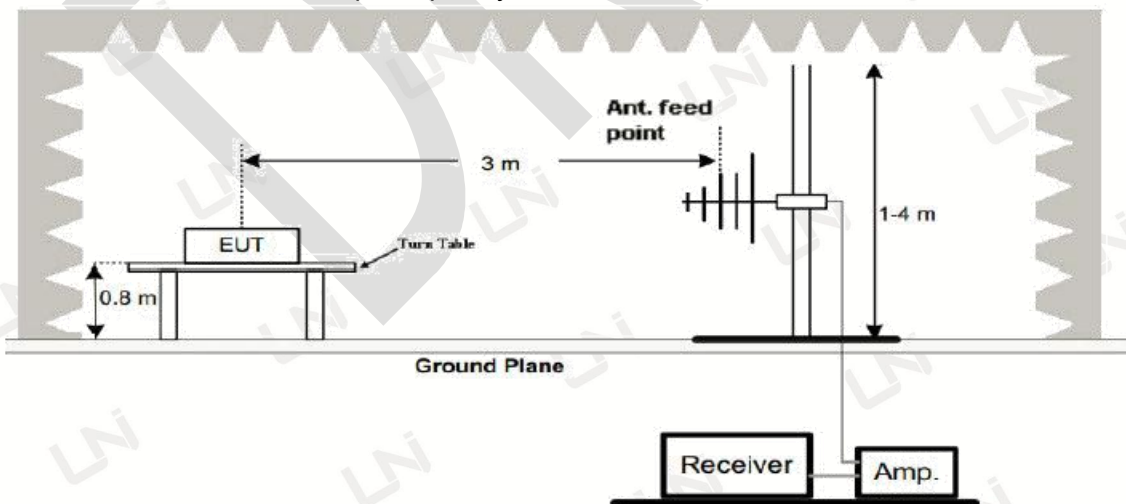

3. Radiated Emission Test-Up Frequency Above 1GHz

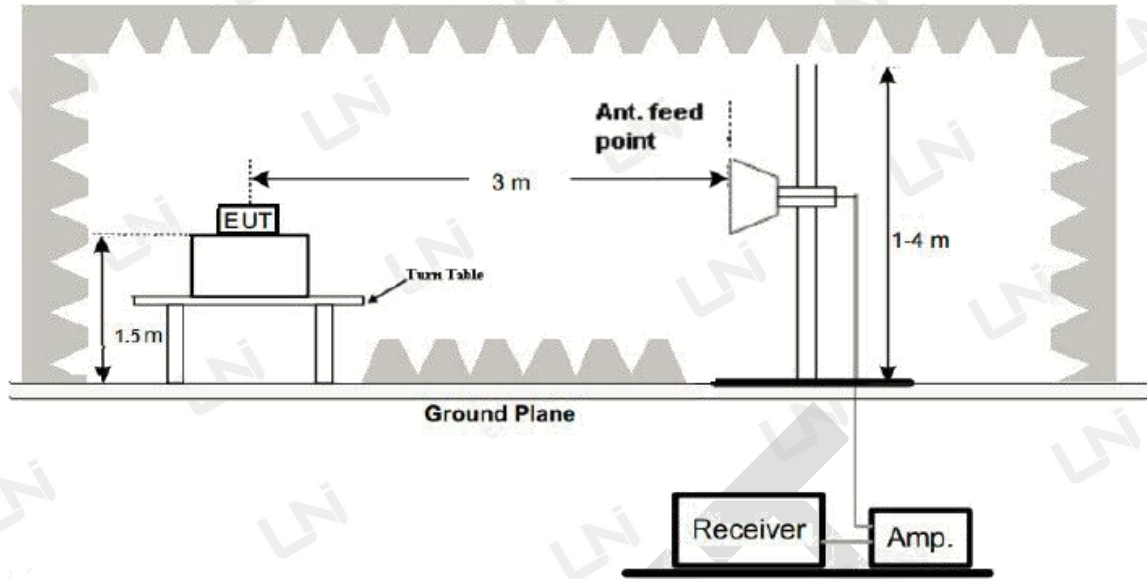

4.3 Test Procedure

1. Below 1GHz measurement the EUT is placed on turntable which is 0.8m above ground plane. And above 1GHz measurement EUT was placed on low permittivity and low tangent turn table which is 1.5m above ground plane.
2. The turntable shall be rotated for 360 degrees to determine the position of maximum emission level.
3. EUT is set 3m away from the receiving antenna, which is varied from 1m to 4m to find out the highest emissions.
4. Maximum procedure was performed on the six highest emissions to ensure EUT compliance.
5. And also, each emission was to be maximized by changing the polarization of receiving antenna both horizontal and vertical.
6. Repeat above procedures until the measurements for all frequencies are complete.
7. The test frequency range from 9KHz to 25GHz per FCC PART 15.33(a).

Note:

For battery operated equipment, the equipment tests shall be performed using a new battery.

4.4 Test Result

PASS

Remark:

1. All modes of 802.11b/g/n20/n40 were test at Low, Middle, and High channel, only the worst result of 802.11b High Channel was reported for below 1GHz test.
2. By preliminary testing and verifying three axis (X, Y and Z) position of EUT transmitted status, it was found that "Z axis" position was the worst, and test data recorded in this report.

Below 1GHz Test Results:

Temperature:	24°C	Relative Humidity:	48%
Test Date:	Jul. 14, 2019	Pressure:	1030hPa
Test Voltage:	DC 12V	Polarization:	Horizontal
Test Mode:	Transmitting mode of 802.11b 2462MHz		

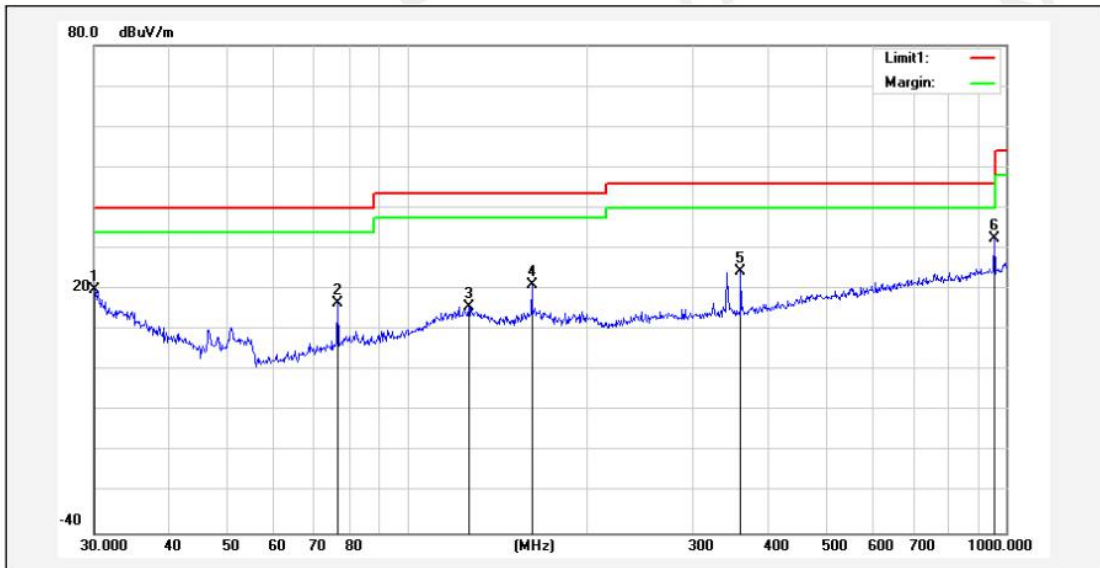

No.	Frequency (MHz)	Reading (dBuV)	Correction factor(dB/m)	Result (dBuV/m)	Limit (dBuV/m)	Margin (dB)	Degree (deg.)	Height (cm)	Remark
1	30.0000	30.00	-10.21	19.79	40.00	-20.21			peak
2	76.5121	36.46	-19.83	16.63	40.00	-23.37			peak
3	126.7723	27.88	-12.26	15.62	43.50	-27.88			peak
4	161.4742	32.82	-11.78	21.04	43.50	-22.46			peak
5	360.4477	35.81	-11.53	24.28	46.00	-21.72			peak
6*	955.4381	33.82	-1.48	32.34	46.00	-13.66			peak

Remark: Absolute Level = Reading Level + Factor, Margin = Absolute Level – Limit
 Factor = Ant. Factor + Cable Loss – Pre-amplifier

Temperature:	24°C	Relative Humidity:	48%
Test Date:	Jul. 14, 2019	Pressure:	1030hPa
Test Voltage:	DC 12V	Polarization:	Vertical
Test Mode:	Transmitting mode of 802.11b 2462MHz		

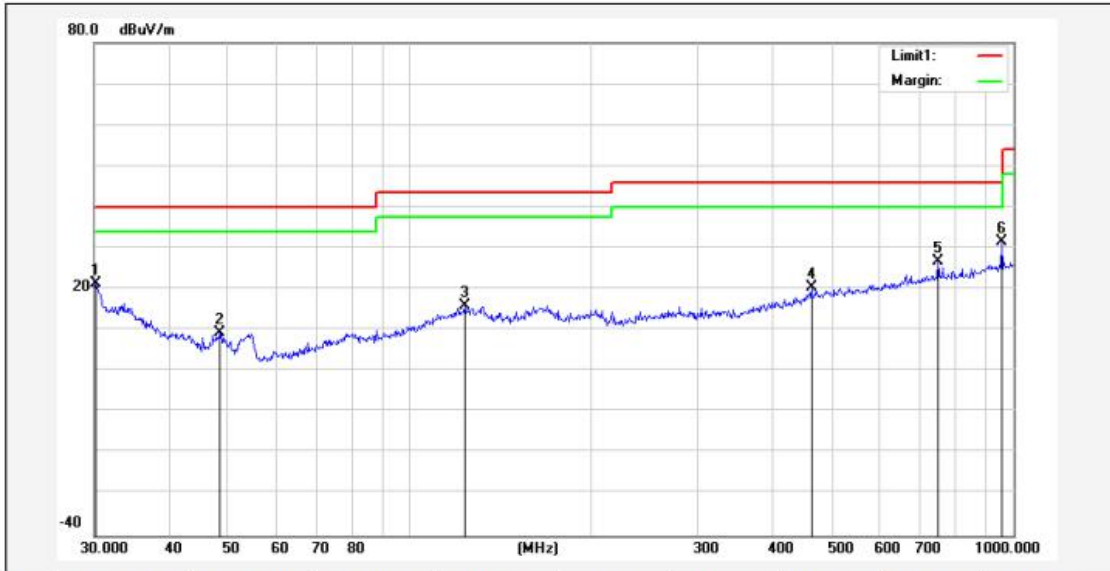

No.	Frequency (MHz)	Reading (dBuV)	Correction factor (dB/m)	Result (dBuV/m)	Limit (dBuV/m)	Margin (dB)	Degree (deg.)	Height (cm)	Remark
1	30.2111	32.12	-10.86	21.26	40.00	-18.74			peak
2	48.5016	33.81	-24.45	9.36	40.00	-30.64			peak
3	123.2655	29.46	-13.49	15.97	43.50	-27.53			peak
4	462.3455	31.32	-10.84	20.48	46.00	-25.52			peak
5	750.1083	33.78	-7.10	26.68	46.00	-19.32			peak
6*	955.4381	36.60	-4.90	31.70	46.00	-14.30			peak

Remark: Absolute Level = Reading Level + Factor, Margin = Absolute Level – Limit
 Factor = Ant. Factor + Cable Loss – Pre-amplifier

Remark:

- (1) Measuring frequencies from 9 KHz to the 1 GHz, radiated emission test from 9KHz to 30MHz was verified, and no any emission was found except system noise floor.
- (2) * denotes emission frequency which appearing within the Restricted Bands specified in provision of 15.205, then the general radiated emission limits in 15.209 apply.
- (3) The IF bandwidth of EMI Test Receiver between 30MHz to 1GHz was 120KHz, 1 MHz for measuring above 1 GHz, below 30MHz was 10KHz.

Above 1 GHz Test Results:

CH Low of 802.11b Mode (2412MHz)

Horizontal:

Frequency (MHz)	Reading Result (dBμV)	Factor (dB)	Emission Level (dBμV/m)	Limits (dBμV/m)	Margin (dB)	Detector Type
4824	61.26	-3.64	57.62	74	-16.38	PK
4824	51.34	-3.64	47.70	54	-6.30	AV
7236	57.98	-0.95	57.03	74	-16.97	PK
7236	47.19	-0.95	46.24	54	-7.76	AV

Remark: Factor = Antenna Factor + Cable Loss – Pre-amplifier. Margin = Absolute Level – Limit

Vertical:

Frequency (MHz)	Reading Result (dBμV)	Factor (dB)	Emission Level (dBμV/m)	Limits (dBμV/m)	Margin (dB)	Detector Type
4824	61.82	-3.64	58.18	74	-15.82	PK
4824	51.23	-3.64	47.59	54	-6.41	AV
7236	58.36	-0.95	57.41	74	-16.59	PK
7236	47.69	-0.95	46.74	54	-7.26	AV

Remark: Factor = Antenna Factor + Cable Loss – Pre-amplifier. Margin = Absolute Level – Limit

CH Middle of 802.11b Mode (2437MHz)

Horizontal:

Frequency (MHz)	Reading Result (dBμV)	Factor (dB)	Emission Level (dBμV/m)	Limits (dBμV/m)	Margin (dB)	Detector Type
4874	62.64	-3.51	59.13	74	-14.87	PK
4874	51.01	-3.51	47.50	54	-6.50	AV
7311	58.71	-0.82	57.89	74	-16.11	PK
7311	47.99	-0.82	47.17	54	-6.83	AV

Remark: Factor = Antenna Factor + Cable Loss – Pre-amplifier. Margin = Absolute Level – Limit

Vertical:

Frequency (MHz)	Reading Result (dBμV)	Factor (dB)	Emission Level (dBμV/m)	Limits (dBμV/m)	Margin (dB)	Detector Type
4874	62.86	-3.51	59.35	74	-14.65	PK
4874	52.39	-3.51	48.88	54	-5.12	AV
7311	58.61	-0.82	57.79	74	-16.21	PK
7311	47.39	-0.82	46.57	54	-7.43	AV

Remark: Factor = Antenna Factor + Cable Loss – Pre-amplifier. Margin = Absolute Level – Limit

CH High of 802.11b Mode (2462MHz)

Horizontal:

Frequency (MHz)	Reading Result (dBμV)	Factor (dB)	Emission Level (dBμV/m)	Limits (dBμV/m)	Margin (dB)	Detector Type
4924	61.52	-3.43	58.09	74	-15.91	PK
4924	50.29	-3.43	46.86	54	-7.14	AV
7386	57.96	-0.75	57.21	74	-16.79	PK
7386	47.62	-0.75	46.87	54	-7.13	AV

Remark: Factor = Antenna Factor + Cable Loss – Pre-amplifier. Margin = Absolute Level – Limit

Vertical:

Frequency (MHz)	Reading Result (dBμV)	Factor (dB)	Emission Level (dBμV/m)	Limits (dBμV/m)	Margin (dB)	Detector Type
4924	61.39	-3.43	57.96	74	-16.04	PK
4924	51.02	-3.43	47.59	54	-6.41	AV
7386	58.66	-0.75	57.91	74	-16.09	PK
7386	47.29	-0.75	46.54	54	-7.46	AV

Remark: Factor = Antenna Factor + Cable Loss – Pre-amplifier. Margin = Absolute Level – Limit

Remark:

- (1) Measuring frequencies from 1 GHz to the 25 GHz.
- (2) "F" denotes fundamental frequency; "H" denotes spurious frequency. "E" denotes band edge frequency.
- (3) * denotes emission frequency which appearing within the Restricted Bands specified in provision of 15.205, then the general radiated emission limits in 15.209 apply.
- (4) Data of measurement within this frequency range shown "---" in the table above means the reading of emissions are attenuated more than 20dB below the permissible limits or the field strength is too small to be measured.
- (5) The IF bandwidth of EMI Test Receiver between 30MHz to 1GHz was 120KHz, 1 MHz for measuring above 1 GHz, below 30MHz was 10KHz. The resolution bandwidth of test receiver/spectrum analyzer is 1MHz and video bandwidth is 3MHz for peak measurement with peak detector at frequency above 1GHz. The resolution bandwidth of test receiver/spectrum analyzer is 1MHz and video bandwidth is 10Hz for Average measurement with peak detection at frequency above 1GHz.
- (6) When the test results of Peak Detected below the limits of Average Detected, the Average Detected is not need completed. For example: Top Channel at Fundamental 73.16dBuV/m(PK Value) <93.98(AV Limit), at harmonic 53.20 dBuV/m(PK Value) <54 dBuV/m(AV Limit), the Average Detected not need to completed.

CH Low of 802.11g Mode (2412MHz)

Horizontal:

Frequency (MHz)	Reading Result (dBμV)	Factor (dB)	Emission Level (dBμV/m)	Limits (dBμV/m)	Margin (dB)	Detector Type
4824	61.88	-3.64	58.24	74	-15.76	PK
4824	50.61	-3.64	46.97	54	-7.03	AV
7236	57.68	-0.95	56.73	74	-17.27	PK
7236	47.65	-0.95	46.70	54	-7.30	AV

Remark: Factor = Antenna Factor + Cable Loss – Pre-amplifier. Margin = Absolute Level – Limit

Vertical:

Frequency (MHz)	Reading Result (dBμV)	Factor (dB)	Emission Level (dBμV/m)	Limits (dBμV/m)	Margin (dB)	Detector Type
4824	62.29	-3.64	58.65	74	-15.35	PK
4824	51.35	-3.64	47.71	54	-6.29	AV
7236	57.06	-0.95	56.11	74	-17.89	PK
7236	47.39	-0.95	46.44	54	-7.56	AV

Remark: Factor = Antenna Factor + Cable Loss – Pre-amplifier. Margin = Absolute Level – Limit

CH Middle of 802.11g Mode (2437MHz)

Horizontal:

Frequency (MHz)	Reading Result (dBμV)	Factor (dB)	Emission Level (dBμV/m)	Limits (dBμV/m)	Margin (dB)	Detector Type
4874	63.02	-3.51	59.51	74	-14.49	PK
4874	51.01	-3.51	47.50	54	-6.50	AV
7311	58.61	-0.82	57.79	74	-16.21	PK
7311	47.29	-0.82	46.47	54	-7.53	AV

Remark: Factor = Antenna Factor + Cable Loss – Pre-amplifier. Margin = Absolute Level – Limit

Vertical:

Frequency (MHz)	Reading Result (dBμV)	Factor (dB)	Emission Level (dBμV/m)	Limits (dBμV/m)	Margin (dB)	Detector Type
4874	62.03	-3.51	58.52	74	-15.48	PK
4874	51.01	-3.51	47.50	54	-6.50	AV
7311	57.92	-0.82	57.10	74	-16.90	PK
7311	47.49	-0.82	46.67	54	-7.33	AV

Remark: Factor = Antenna Factor + Cable Loss – Pre-amplifier. Margin = Absolute Level – Limit

CH High of 802.11g Mode (2462MHz)

Horizontal:

Frequency (MHz)	Reading Result (dBμV)	Factor (dB)	Emission Level (dBμV/m)	Limits (dBμV/m)	Margin (dB)	Detector Type
4924	61.39	-3.43	57.96	74	-16.04	PK
4924	50.37	-3.43	46.94	54	-7.06	AV
7386	58.45	-0.75	57.7	74	-16.3	PK
7386	47.62	-0.75	46.87	54	-7.13	AV

Remark: Factor = Antenna Factor + Cable Loss – Pre-amplifier. Margin = Absolute Level – Limit

Vertical:

Frequency (MHz)	Reading Result (dBμV)	Factor (dB)	Emission Level (dBμV/m)	Limits (dBμV/m)	Margin (dB)	Detector Type
4924	61.52	-3.43	58.09	74	-15.91	PK
4924	50.69	-3.43	47.26	54	-6.74	AV
7386	58.31	-0.75	57.56	74	-16.44	PK
7386	47.38	-0.75	46.63	54	-7.37	AV

Remark: Factor = Antenna Factor + Cable Loss – Pre-amplifier. Margin = Absolute Level – Limit

Remark:

- (1) Measuring frequencies from 1 GHz to the 25 GHz.
- (2) "F" denotes fundamental frequency; "H" denotes spurious frequency. "E" denotes band edge frequency.
- (3) * denotes emission frequency which appearing within the Restricted Bands specified in provision of 15.205, then the general radiated emission limits in 15.209 apply.
- (4) Data of measurement within this frequency range shown "---" in the table above means the reading of emissions are attenuated more than 20dB below the permissible limits or the field strength is too small to be measured.
- (5) The IF bandwidth of EMI Test Receiver between 30MHz to 1GHz was 120KHz, 1 MHz for measuring above 1 GHz, below 30MHz was 10KHz. The resolution bandwidth of test receiver/spectrum analyzer is 1MHz and video bandwidth is 3MHz for peak measurement with peak detector at frequency above 1GHz. The resolution bandwidth of test receiver/spectrum analyzer is 1MHz and video bandwidth is 10Hz for Average measurement with peak detection at frequency above 1GHz.
- (6) When the test results of Peak Detected below the limits of Average Detected, the Average Detected is not need completed. For example: Top Channel at Fundamental 73.16dBuV/m(PK Value) <93.98(AV Limit), at harmonic 53.20 dBuV/m(PK Value) <54 dBuV/m(AV Limit), the Average Detected not need to completed.

CH Low of 802.11n/H20 Mode (2412MHz)

Horizontal:

Frequency (MHz)	Reading Result (dBμV)	Factor (dB)	Emission Level (dBμV/m)	Limits (dBμV/m)	Margin (dB)	Detector Type
4824	62.13	-3.64	58.49	74	-15.51	PK
4824	50.36	-3.64	46.72	54	-7.28	AV
7236	57.64	-0.95	56.69	74	-17.31	PK
7236	47.41	-0.95	46.46	54	-7.54	AV

Remark: Factor = Antenna Factor + Cable Loss – Pre-amplifier. Margin = Absolute Level – Limit

Vertical:

Frequency (MHz)	Reading Result (dBμV)	Factor (dB)	Emission Level (dBμV/m)	Limits (dBμV/m)	Margin (dB)	Detector Type
4824	61.59	-3.64	57.95	74	-16.05	PK
4824	50.39	-3.64	46.75	54	-7.25	AV
7236	57.16	-0.95	56.21	74	-17.79	PK
7236	47.03	-0.95	46.08	54	-7.92	AV

Remark: Factor = Antenna Factor + Cable Loss – Pre-amplifier. Margin = Absolute Level – Limit

CH Middle of 802.11n/H20 Mode (2437MHz)

Horizontal:

Frequency (MHz)	Reading Result (dBμV)	Factor (dB)	Emission Level (dBμV/m)	Limits (dBμV/m)	Margin (dB)	Detector Type
4874	61.36	-3.51	57.85	74	-16.15	PK
4874	50.32	-3.51	46.81	54	-7.19	AV
7311	57.96	-0.82	57.14	74	-16.86	PK
7311	47.61	-0.82	46.79	54	-7.21	AV

Remark: Factor = Antenna Factor + Cable Loss – Pre-amplifier. Margin = Absolute Level – Limit

Vertical:

Frequency (MHz)	Reading Result (dBμV)	Factor (dB)	Emission Level (dBμV/m)	Limits (dBμV/m)	Margin (dB)	Detector Type
4874	62.25	-3.51	58.74	74	-15.26	PK
4874	50.36	-3.51	46.85	54	-7.15	AV
7311	57.69	-0.82	56.87	74	-17.13	PK
7311	47.51	-0.82	46.69	54	-7.31	AV

Remark: Factor = Antenna Factor + Cable Loss – Pre-amplifier. Margin = Absolute Level – Limit

CH High of 802.11n/H20 Mode (2462MHz)

Horizontal:

Frequency	Reading Result	Factor	Emission Level	Limits	Margin	Detector
(MHz)	(dBμV)	(dB)	(dBμV/m)	(dBμV/m)	(dB)	Type
4924	62.06	-3.43	58.63	74	-15.37	PK
4924	50.61	-3.43	47.18	54	-6.82	AV
7386	57.48	-0.75	56.73	74	-17.27	PK
7386	47.56	-0.75	46.81	54	-7.19	AV

Remark: Factor = Antenna Factor + Cable Loss – Pre-amplifier. Margin = Absolute Level – Limit

Vertical:

Frequency	Reading Result	Factor	Emission Level	Limits	Margin	Detector
(MHz)	(dBμV)	(dB)	(dBμV/m)	(dBμV/m)	(dB)	Type
4924	61.39	-3.43	57.96	74	-16.04	PK
4924	50.57	-3.43	47.14	54	-6.86	AV
7386	57.82	-0.75	57.07	74	-16.93	PK
7386	47.69	-0.75	46.94	54	-7.06	AV

Remark: Factor = Antenna Factor + Cable Loss – Pre-amplifier. Margin = Absolute Level – Limit

Remark:

- (1) Measuring frequencies from 1 GHz to the 25 GHz.
- (2) "F" denotes fundamental frequency; "H" denotes spurious frequency. "E" denotes band edge frequency.
- (3) * denotes emission frequency which appearing within the Restricted Bands specified in provision of 15.205, then the general radiated emission limits in 15.209 apply.
- (4) Data of measurement within this frequency range shown "---" in the table above means the reading of emissions are attenuated more than 20dB below the permissible limits or the field strength is too small to be measured.
- (5) The IF bandwidth of EMI Test Receiver between 30MHz to 1GHz was 120KHz, 1 MHz for measuring above 1 GHz, below 30MHz was 10KHz. The resolution bandwidth of test receiver/spectrum analyzer is 1MHz and video bandwidth is 3MHz for peak measurement with peak detector at frequency above 1GHz. The resolution bandwidth of test receiver/spectrum analyzer is 1MHz and video bandwidth is 10Hz for Average measurement with peak detection at frequency above 1GHz.
- (6) When the test results of Peak Detected below the limits of Average Detected, the Average Detected is not need completed. For example: Top Channel at Fundamental 73.16dBuV/m(PK Value) <93.98(AV Limit), at harmonic 53.20 dBuV/m(PK Value) <54 dBuV/m(AV Limit), the Average Detected not need to completed.

5 BAND EDGE

5.1 Limits

FCC PART 15.247 Emissions radiated outside of the specified frequency bands, except for harmonics, shall be attenuated by at least 50 dB below the level of the fundamental or to the general radiated emission limits in §15.209, whichever is the lesser attenuation.

5.2 Test Procedure

The band edge compliance of RF radiated emission should be measured by following the guidance in ANSI C63.10 with respect to maximizing the emission by rotating the EUT, measuring the emission while the EUT is situated in three orthogonal planes (if appropriate), adjusting the measurement antenna height and polarization etc. Set RBW to 100KHz and VBM to 300KHz to measure the peak field strength and set RBW to 1MHz and VBW to 10Hz to measure the average radiated field strength. The conducted RF band edge was measured by using a spectrum analyzer. Set span wide enough to capture the highest in-band emission and the emission at the band edge. Set RBW to 100 KHz and VBW to 300 KHz, to measure the conducted peak band edge.

5.3 Test Result

PASS

Operation Mode: 802.11b Mode TX CH Low (2412MHz)

Horizontal:

Frequency (MHz)	Reading Result (dBμV)	Factor (dB)	Emission Level (dBμV/m)	Limits (dBμV/m)	Margin (dB)	Detector Type
2310	55.69	-5.81	49.88	74	-24.12	PK
2310	/	-5.81	/	54	/	AV
2390	65.57	-5.84	59.73	74	-14.27	PK
2390	48.26	-5.84	42.42	54	-11.58	AV
2400	65.2	-5.84	59.36	74	-14.64	PK
2400	50.05	-5.84	44.21	54	-9.79	AV

Remark: Factor = Antenna Factor + Cable Loss – Pre-amplifier.

Vertical:

Frequency (MHz)	Reading Result (dBμV)	Factor (dB)	Emission Level (dBμV/m)	Limits (dBμV/m)	Margin (dB)	Detector Type
2310	55.36	-5.81	49.55	74	-24.45	PK
2310	/	-5.81	/	54	/	AV
2390	64.59	-5.84	58.75	74	-15.25	PK
2390	48.35	-5.84	42.51	54	-11.49	AV
2400	65.81	-5.84	59.97	74	-14.03	PK
2400	49.31	-5.84	43.47	54	-10.53	AV

Remark: Factor = Antenna Factor + Cable Loss – Pre-amplifier.

Operation Mode: 802.11b Mode TX CH High (2462MHz)

Horizontal:

Frequency	Reading Result	Factor	Emission Level	Limits	Margin	Detector Type
(MHz)	(dBμV)	(dB)	(dBμV/m)	(dBμV/m)	(dB)	
2483.5	57.39	-5.65	51.74	74	-22.26	PK
2483.5	/	-5.65	/	54	/	AV
2500	55.18	-5.72	49.46	74	-24.54	PK
2500	/	-5.72	/	54	/	AV

Remark: Factor = Antenna Factor + Cable Loss – Pre-amplifier.

Vertical:

Frequency	Reading Result	Factor	Emission Level	Limits	Margin	Detector Type
(MHz)	(dBμV)	(dB)	(dBμV/m)	(dBμV/m)	(dB)	
2483.5	56.21	-5.65	50.56	74	-23.44	PK
2483.5	/	-5.65	/	54	/	AV
2500	55.68	-5.72	49.96	74	-24.04	PK
2500	/	-5.72	/	54	/	AV

Remark: Factor = Antenna Factor + Cable Loss – Pre-amplifier.

Operation Mode: 802.11g Mode TX CH Low (2412MHz)

Horizontal:

Frequency (MHz)	Reading Result (dBμV)	Factor (dB)	Emission Level (dBμV/m)	Limits (dBμV/m)	Margin (dB)	Detector Type
2310	56.39	-5.81	50.58	74	-23.42	PK
2310	/	-5.81	/	54	/	AV
2390	63.84	-5.84	58.00	74	-16.00	PK
2390	47.31	-5.84	41.47	54	-12.53	AV
2400	65.25	-5.84	59.41	74	-14.59	PK
2400	50.39	-5.84	44.55	54	-9.45	AV

Remark: Factor = Antenna Factor + Cable Loss – Pre-amplifier.

Vertical:

Frequency (MHz)	Reading Result (dBμV)	Factor (dB)	Emission Level (dBμV/m)	Limits (dBμV/m)	Margin (dB)	Detector Type
2310	56.24	-5.81	50.43	74	-23.57	PK
2310	/	-5.81	/	54	/	AV
2390	63.95	-5.84	58.11	74	-15.89	PK
2390	48.21	-5.84	42.37	54	-11.63	AV
2400	64.02	-5.84	58.18	74	-15.82	PK
2400	50.39	-5.84	44.55	54	-9.45	AV

Remark: Factor = Antenna Factor + Cable Loss – Pre-amplifier.

Operation Mode: 802.11g Mode TX CH High (2462MHz)

Horizontal:

Frequency	Reading Result	Factor	Emission Level	Limits	Margin	Detector Type
(MHz)	(dBμV)	(dB)	(dBμV/m)	(dBμV/m)	(dB)	
2483.5	57.96	-5.65	52.31	74	-21.69	PK
2483.5	/	-5.65	/	54	/	AV
2500	56.31	-5.72	50.59	74	-23.41	PK
2500	/	-5.72	/	54	/	AV

Remark: Factor = Antenna Factor + Cable Loss – Pre-amplifier.

Vertical:

Frequency	Reading Result	Factor	Emission Level	Limits	Margin	Detector Type
(MHz)	(dBμV)	(dB)	(dBμV/m)	(dBμV/m)	(dB)	
2483.5	57.62	-5.65	51.97	74	-22.03	PK
2483.5	/	-5.65	/	54	/	AV
2500	56.38	-5.72	50.66	74	-23.34	PK
2500	/	-5.72	/	54	/	AV

Remark: Factor = Antenna Factor + Cable Loss – Pre-amplifier.

Operation Mode: 802.11n/H20 Mode TX CH Low (2412MHz)

Horizontal:

Frequency (MHz)	Reading Result (dBμV)	Factor (dB)	Emission Level (dBμV/m)	Limits (dBμV/m)	Margin (dB)	Detector Type
2310	56.82	-5.81	51.01	74	-22.99	PK
2310	/	-5.81	/	54	/	AV
2390	66.67	-5.84	60.83	74	-13.17	PK
2390	48.35	-5.84	42.51	54	-11.49	AV
2400	63.87	-5.84	58.03	74	-15.97	PK
2400	50.02	-5.84	44.18	54	-9.82	AV

Remark: Factor = Antenna Factor + Cable Loss – Pre-amplifier.

Vertical:

Frequency (MHz)	Reading Result (dBμV)	Factor (dB)	Emission Level (dBμV/m)	Limits (dBμV/m)	Margin (dB)	Detector Type
2310	56.31	-5.81	50.5	74	-23.5	PK
2310	/	-5.81	/	54	/	AV
2390	64.38	-5.84	58.54	74	-15.46	PK
2390	49.21	-5.84	43.37	54	-10.63	AV
2400	64.87	-5.84	59.03	74	-14.97	PK
2400	50.69	-5.84	44.85	54	-9.15	AV

Remark: Factor = Antenna Factor + Cable Loss – Pre-amplifier.

Operation Mode: 802.11n/H20 Mode TX CH High (2462MHz)

Horizontal:

Frequency (MHz)	Reading Result (dBμV)	Factor (dB)	Emission Level (dBμV/m)	Limits (dBμV/m)	Margin (dB)	Detector Type
2483.5	58.01	-5.65	52.36	74	-21.64	PK
2483.5	/	-5.65	/	54	/	AV
2500	56.37	-5.72	50.65	74	-23.35	PK
2500	/	-5.72	/	54	/	AV

Remark: Factor = Antenna Factor + Cable Loss – Pre-amplifier.

Vertical:

Frequency (MHz)	Reading Result (dBμV)	Factor (dB)	Emission Level (dBμV/m)	Limits (dBμV/m)	Margin (dB)	Detector Type
2483.5	57.32	-5.65	51.67	74	-22.33	PK
2483.5	/	-5.65	/	54	/	AV
2500	56.81	-5.72	51.09	74	-22.91	PK
2500	/	-5.72	/	54	/	AV

Remark: Factor = Antenna Factor + Cable Loss – Pre-amplifier.

6 OCCUPIED BANDWIDTH MEASUREMENT

6.1 Test Limit

FCC Part15(15.247), Subpart C				
Section	Test Item	Limit	Frequency Range (MHz)	Result
15.247(a)(2)	Bandwidth	$\geq 500\text{KHz}$ (6dB bandwidth)	2400-2483.5	PASS

6.2 Test Procedure

1. The EUT was placed on a turn table which is 0.8m above ground plane.
2. Set EUT as normal operation.
3. Based on FCC Part15 C Section 15.247: RBW=100KHz, VBW=300KHz.
4. The useful radiated emission from the EUT was detected by the spectrum analyzer with peak detector.

6.3 Measurement Equipment Used

Same as Radiated Emission Measurement

6.4 Test Result

PASS

TX 802.11b Mode			
Frequency (MHz)	6dB Bandwidth (MHz)	Channel Separation (MHz)	Result
2412	9.048	>=500KHz	PASS
2437	9.027	>=500KHz	PASS
2462	8.063	>=500KHz	PASS

CH: 2412MHz



CH: 2437MHz

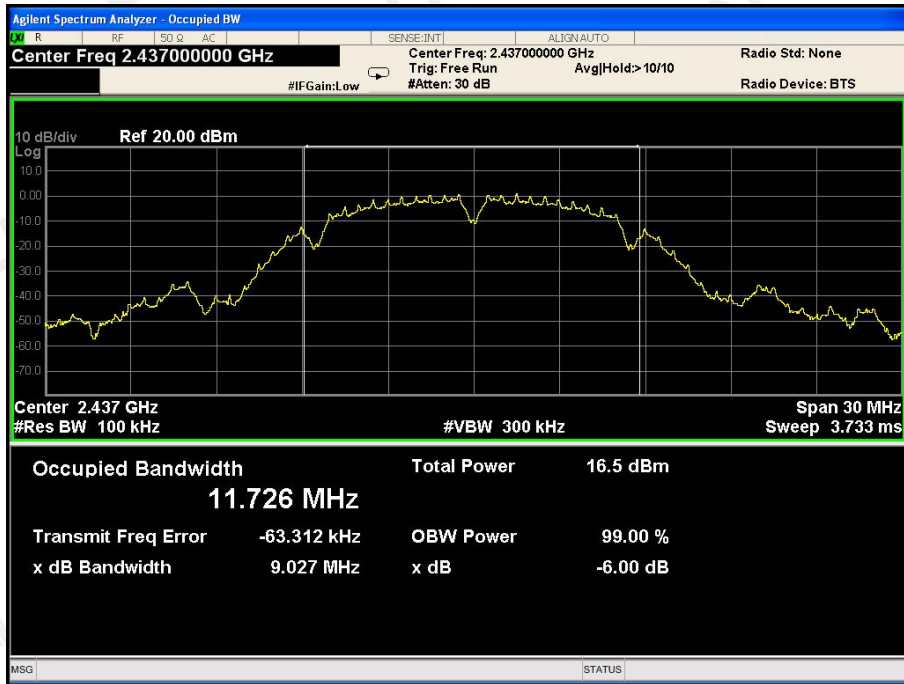

CH: 2462MHz

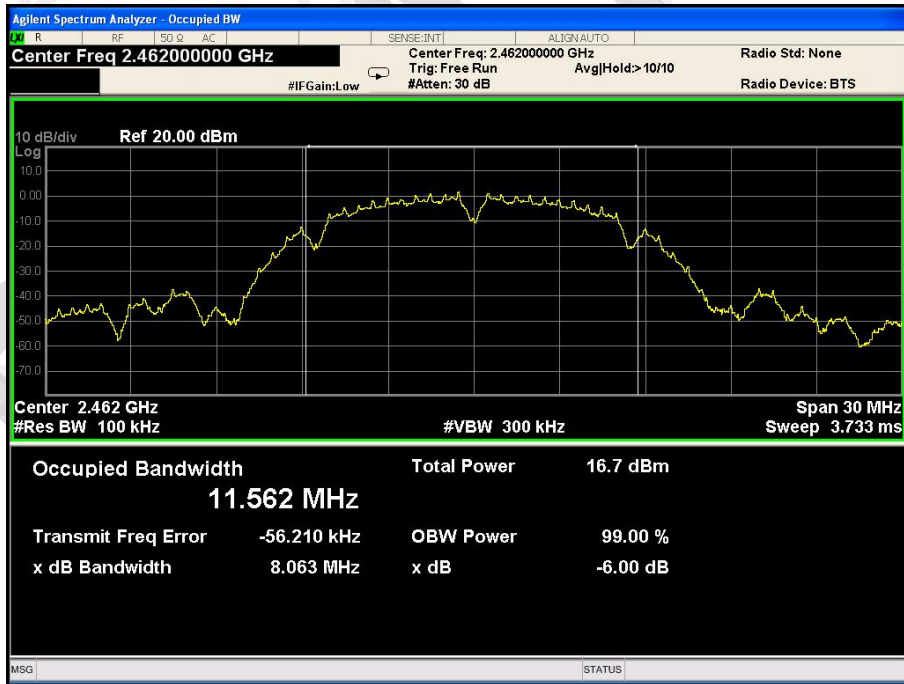

TX 802.11g Mode			
Frequency (MHz)	6dB Bandwidth (MHz)	Channel Separation (MHz)	Result
2412	16.30	>=500KHz	PASS
2437	16.30	>=500KHz	PASS
2462	16.28	>=500KHz	PASS

CH: 2412MHz

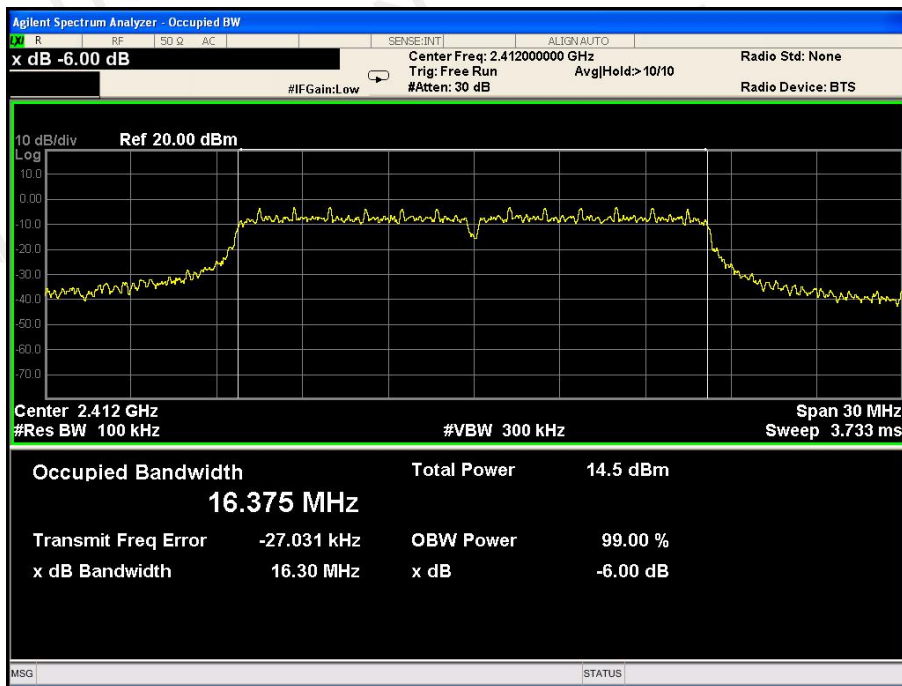

CH: 2437MHz

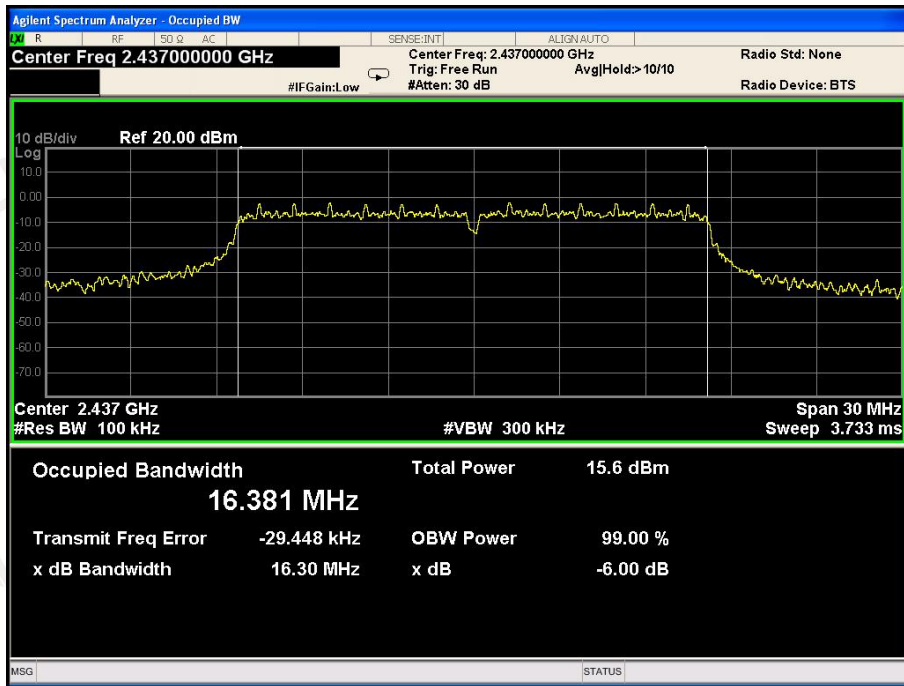

CH: 2462MHz

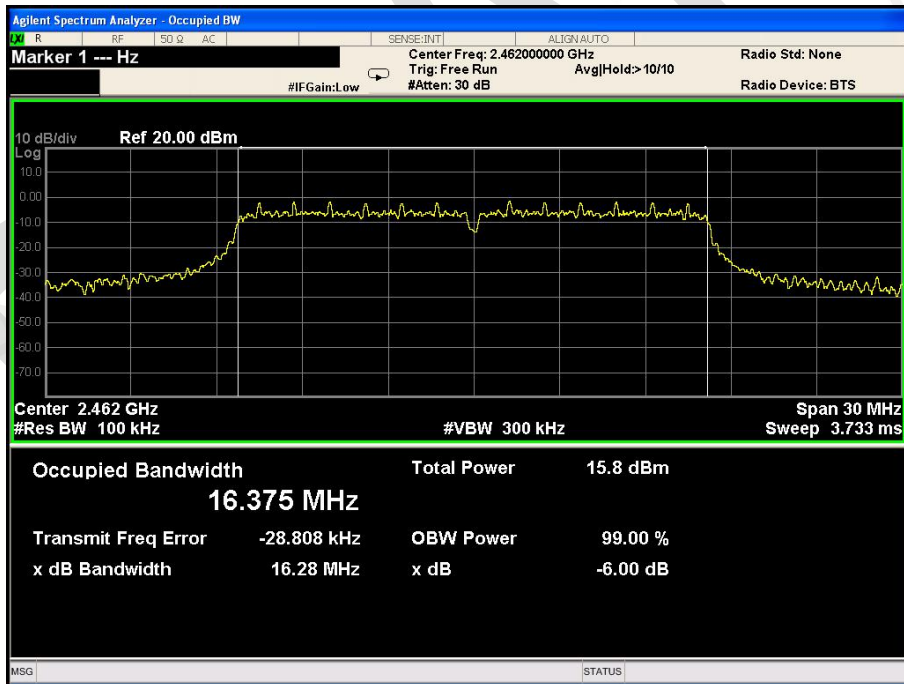

TX 802.11n/HT20 Mode			
Frequency (MHz)	6dB Bandwidth (MHz)	Channel Separation (MHz)	Result
2412	16.32	>=500KHz	PASS
2437	16.56	>=500KHz	PASS
2462	16.54	>=500KHz	PASS

CH: 2412MHz

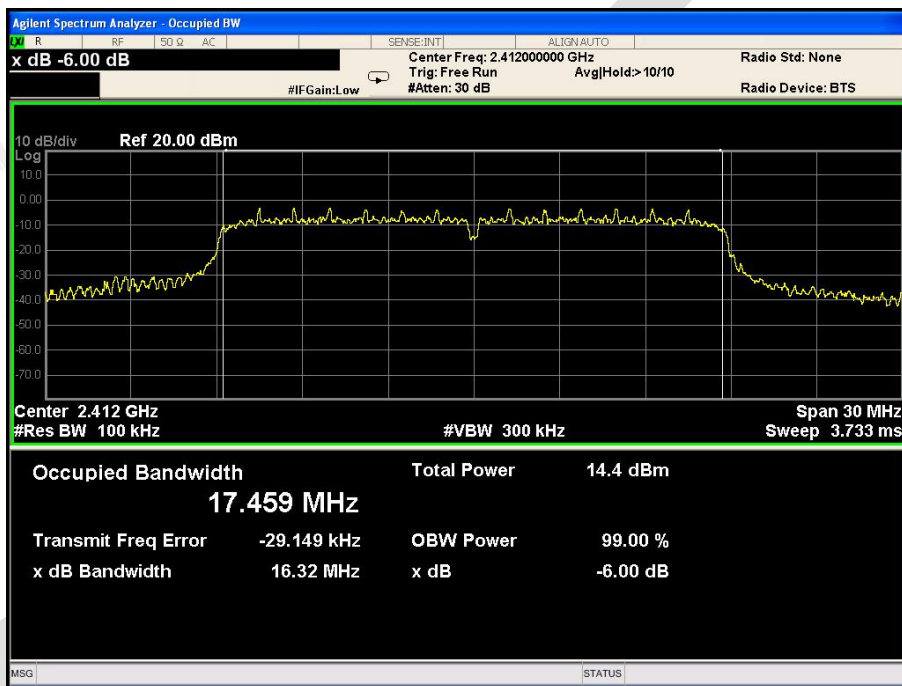

CH: 2437MHz

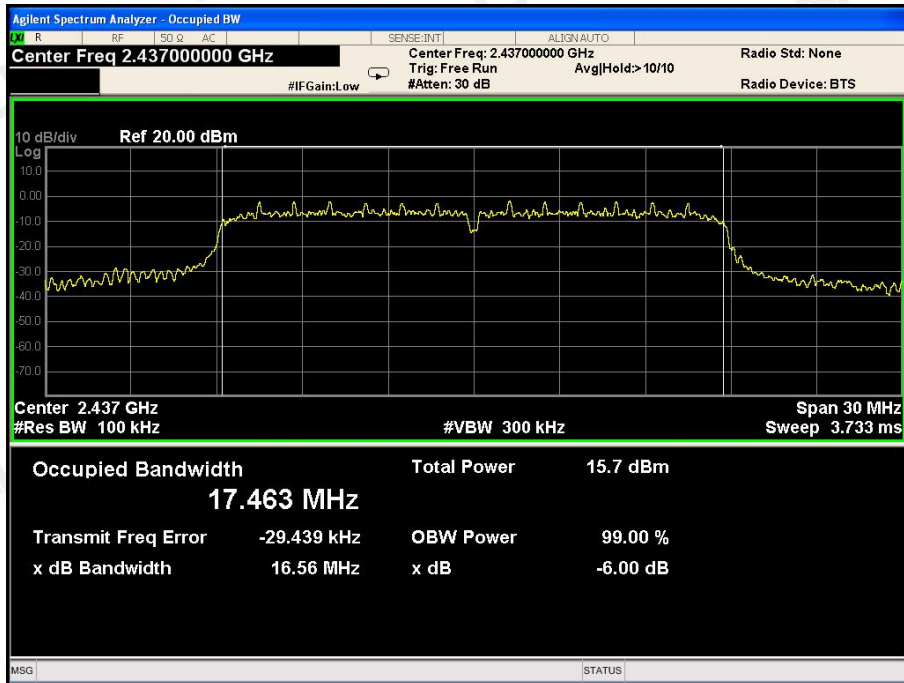

CH: 2462MHz

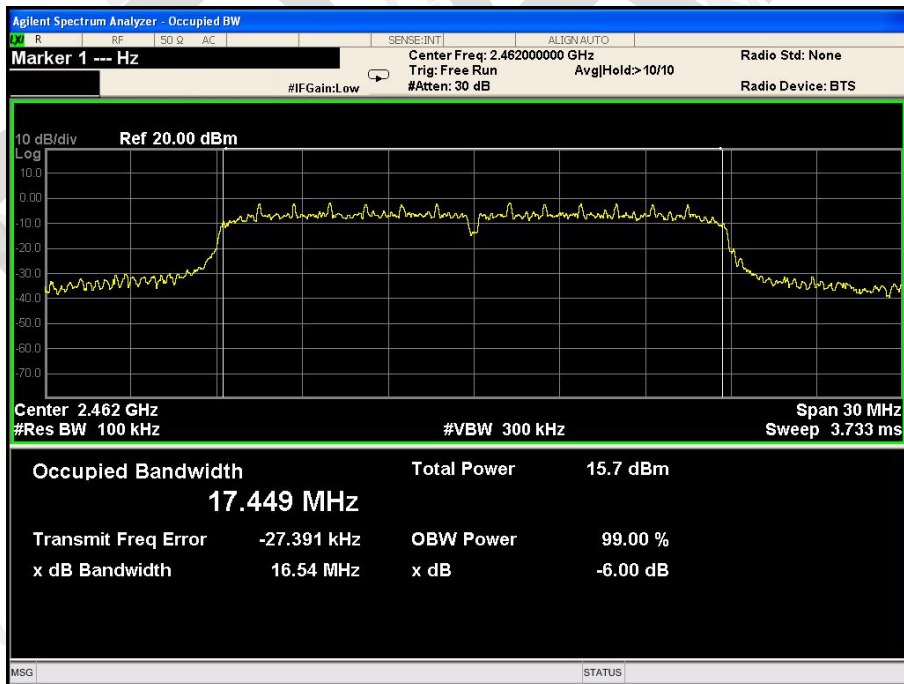

7 POWER SPECTRAL DENSITY TEST

7.1 Test Limit

FCC Part15(15.247), Subpart C				
Section	Test Item	Limit	Frequency Range (MHz)	Result
15.247	Power Spectral Density	8 dBm (in any 3KHz)	2400-2483.5	PASS

7.2 Test Procedure

1. The EUT was placed on a turn table which is 0.8m above ground plane.
2. Set EUT as normal operation.
3. Based on FCC Part15 C Section 15.247: RBW=3KHz, VBW=10KHz.
4. The useful radiated emission from the EUT was detected by the spectrum analyzer with peak detector.

7.3 Measurement Equipment Used

Same as Radiated Emission Measurement

7.4 Test Result

PASS

TX 802.11b Mode			
Frequency (MHz)	Power Density (dBm/3KHz)	Limit (dBm/3KHz)	Result
2412	-11.401	8	PASS
2437	-12.499	8	PASS
2462	-12.386	8	PASS

CH: 2412MHz



CH: 2437MHz

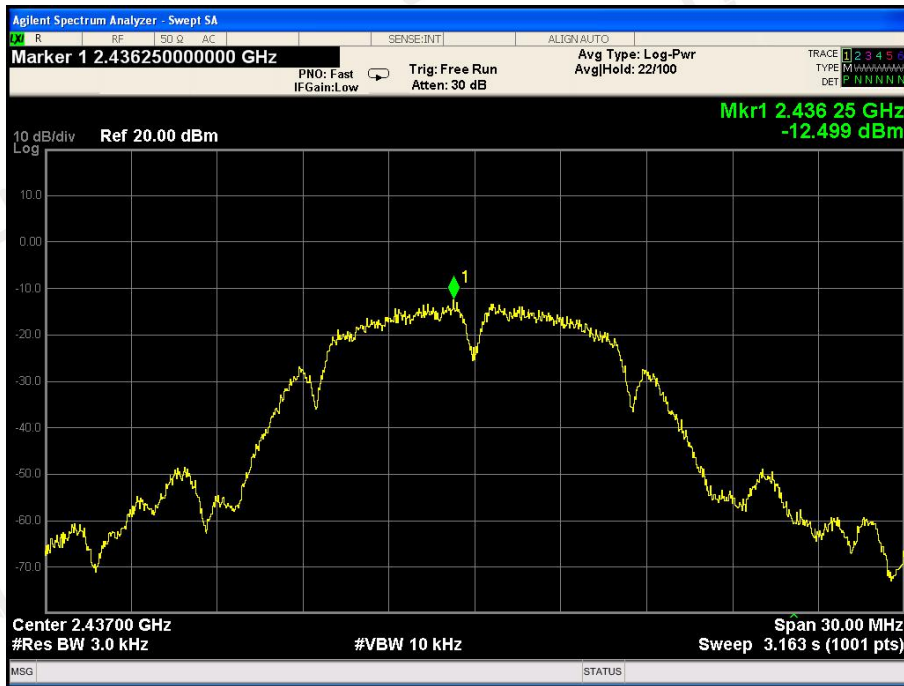

CH: 2462MHz

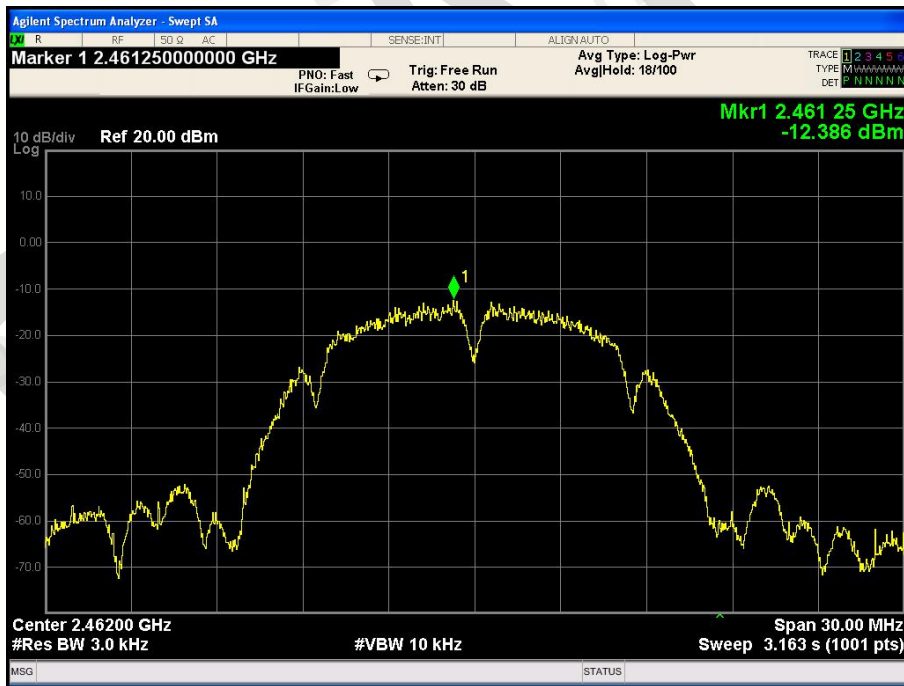

TX 802.11g Mode			
Frequency (MHz)	Power Density (dBm/3KHz)	Limit (dBm/3KHz)	Result
2412	-13.921	8	PASS
2437	-15.164	8	PASS
2462	-14.872	8	PASS

CH: 2412MHz

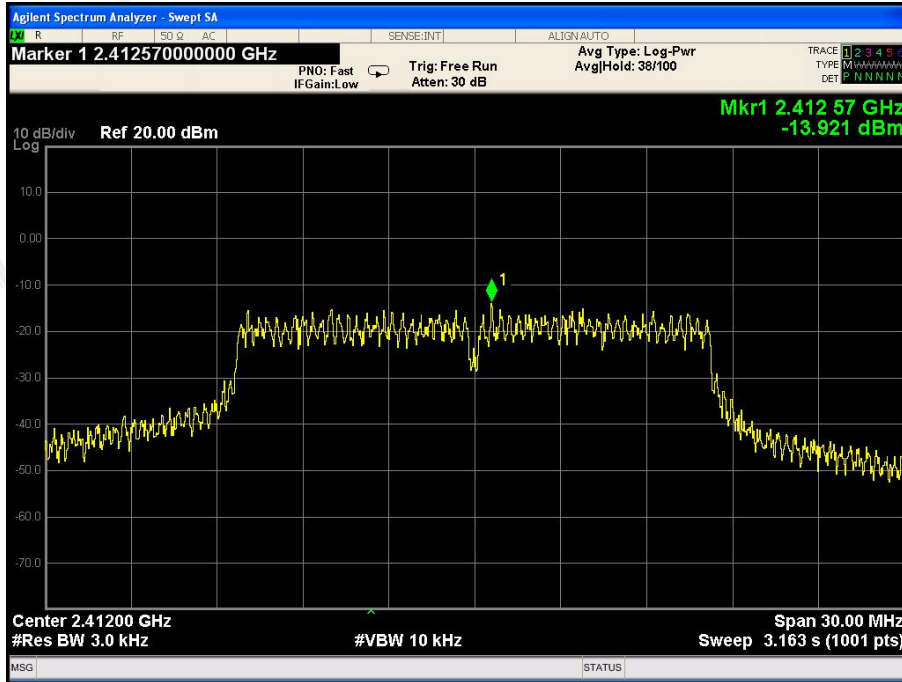

CH: 2437MHz

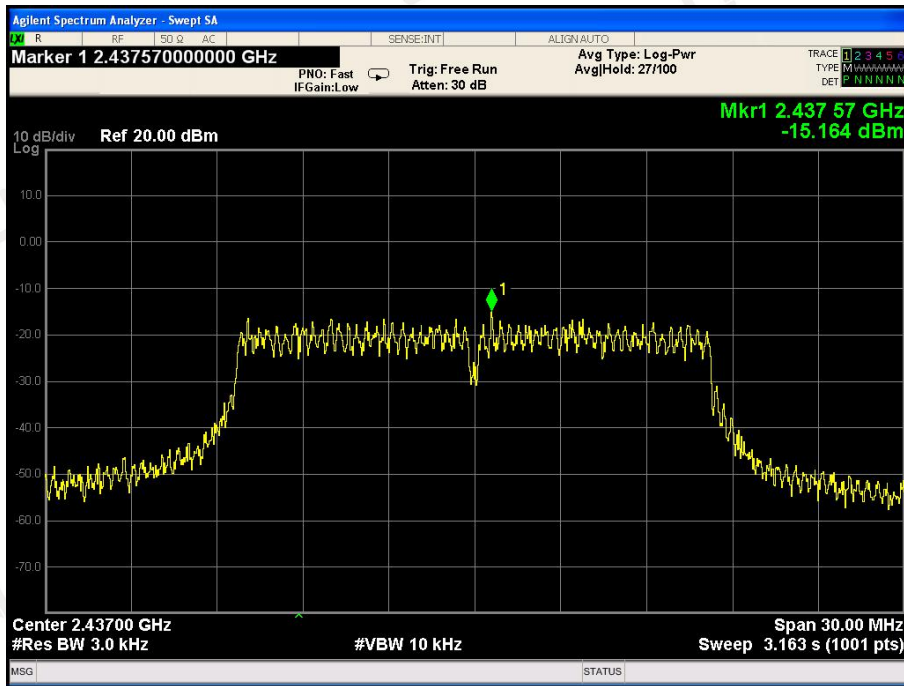

CH: 2462MHz

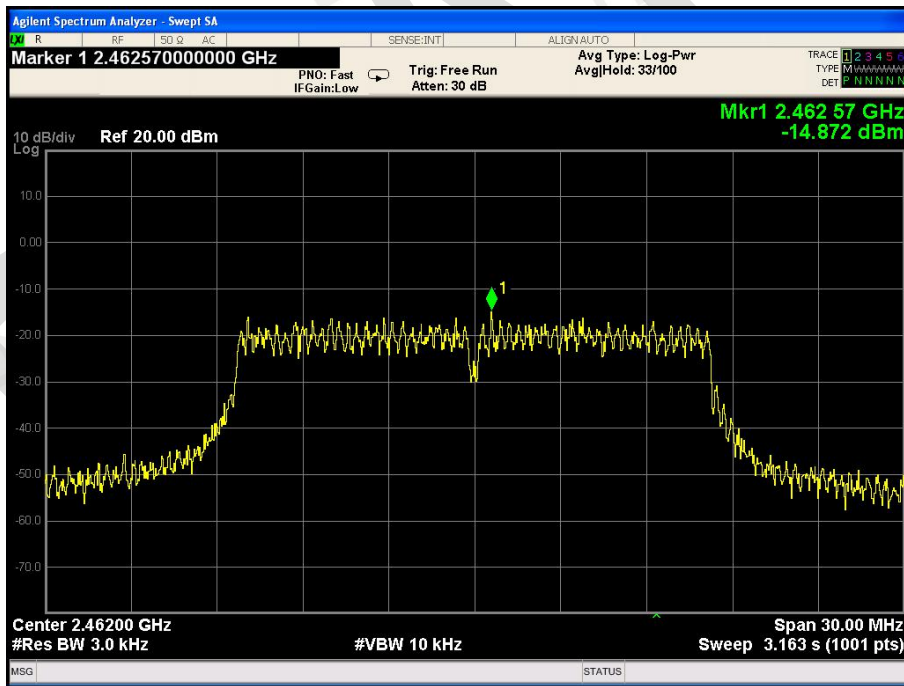

TX 802.11n/HT20 Mode			
Frequency (MHz)	Power Density (dBm/3KHz)	Limit (dBm/3KHz)	Result
2412	-14.052	8	PASS
2437	-15.400	8	PASS
2462	-13.564	8	PASS

CH: 2412MHz

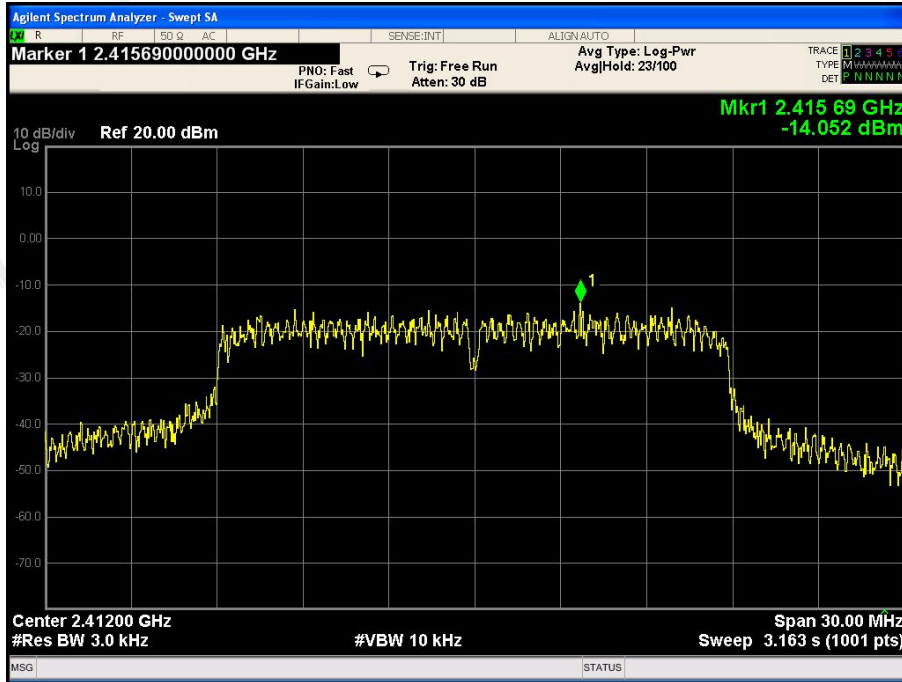

CH: 2437MHz

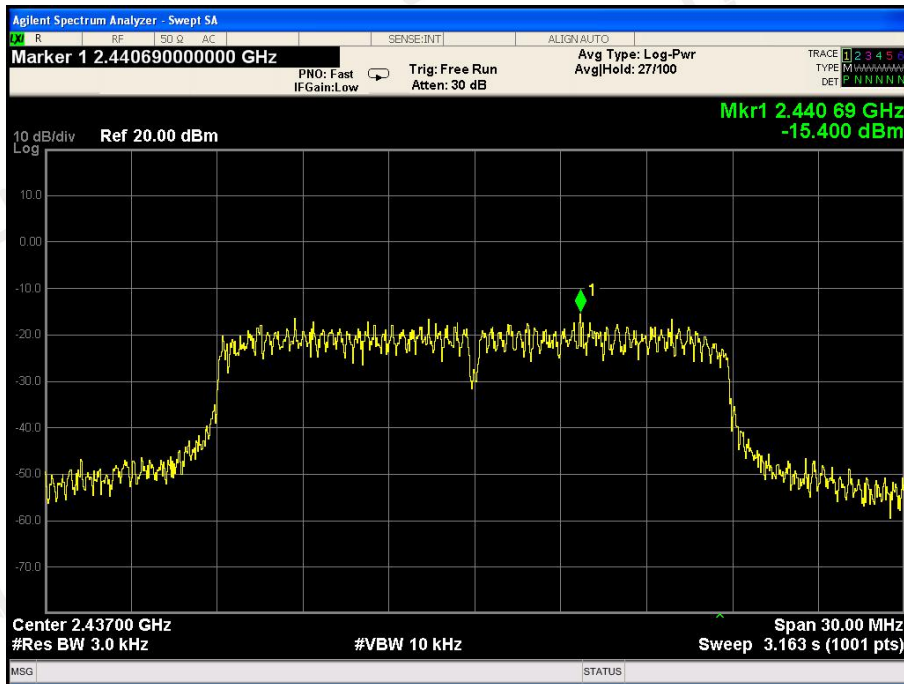

CH: 2462MHz

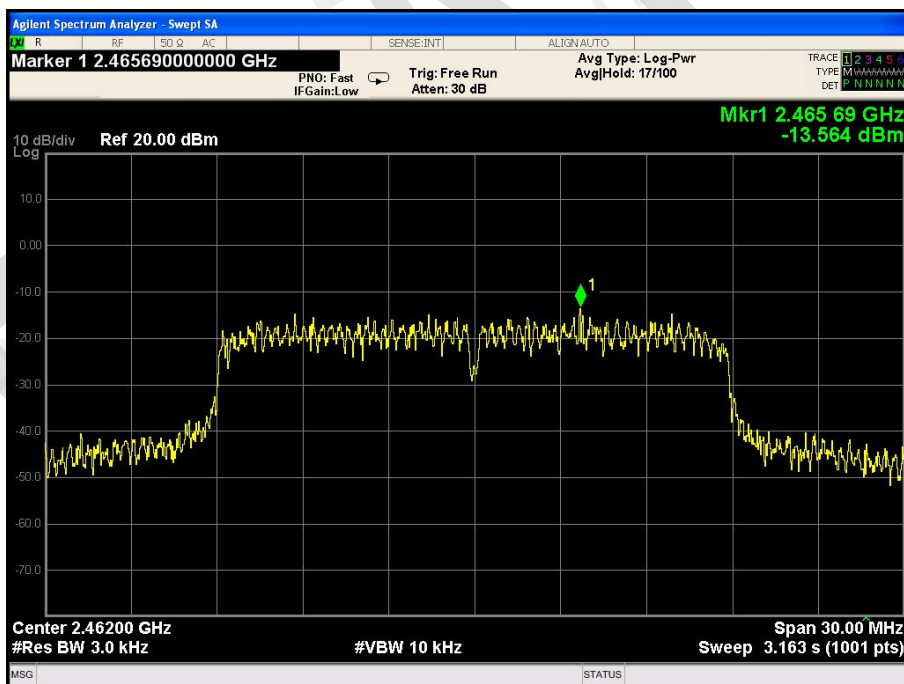

8 PEAK OUTPUT POWER TEST

8.1 Test Limit

FCC Part15(15.247), Subpart C				
Section	Test Item	Limit	Frequency Range (MHz)	Result
15.247(b)(3)	Peak Output Power	1 watt or 30dBm	2400-2483.5	PASS

8.2 Test Procedure

1. The EUT was placed on a turn table which is 0.8m above ground plane.
2. The EUT was directly connected to the Power meter.

8.3 Measurement Equipment Used

Same as Radiated Emission Measurement

8.4 Test Result

PASS

All the test modes completed for test.

TX 802.11b Mode			
Test Channel	Frequency (MHz)	Maximum Peak Conducted Output Power (dBm)	LIMIT (dBm)
CH01	2412	12.25	30
CH06	2437	12.82	30
CH11	2462	12.45	30
TX 802.11g Mode			
CH01	2412	11.51	30
CH06	2437	12.05	30
CH11	2462	11.76	30
TX 802.11n20 Mode			
CH01	2412	11.96	30
CH06	2437	11.67	30
CH11	2462	11.75	30

9 OUT OF BAND EMISSIONS TEST

9.1 Test Limit

In any 100 kHz bandwidth outside the frequency band in which the spread spectrum or digitally modulated intentional radiator is operating, the radio frequency power that is produced by the intentional radiator shall be at least 20 dB below that in the 100 kHz bandwidth within the band that contains the highest level of the desired power, based on either an RF conducted or a radiated measurement, provided the transmitter demonstrates compliance with the peak conducted power limits. If the transmitter complies with the conducted power limits based on the use of RMS averaging over a time interval, as permitted under paragraph (b)(3) of this section, the attenuation required under this paragraph shall be 30 dB instead of 20 dB.

9.2 Test Procedure

1. The EUT was placed on a turn table which is 0.8m above ground plane.
2. Set EUT as TX operation and connect directly to the spectrum analyzer.
3. Based on FCC Part15 C Section 15.247: RBW=100KHz, VBW=300KHz.
4. Set detected by the spectrum analyzer with peak detector.

9.3 Test Setup



9.4 Test Result

PASS

TX 802.11b Mode
CH: 2412MHz

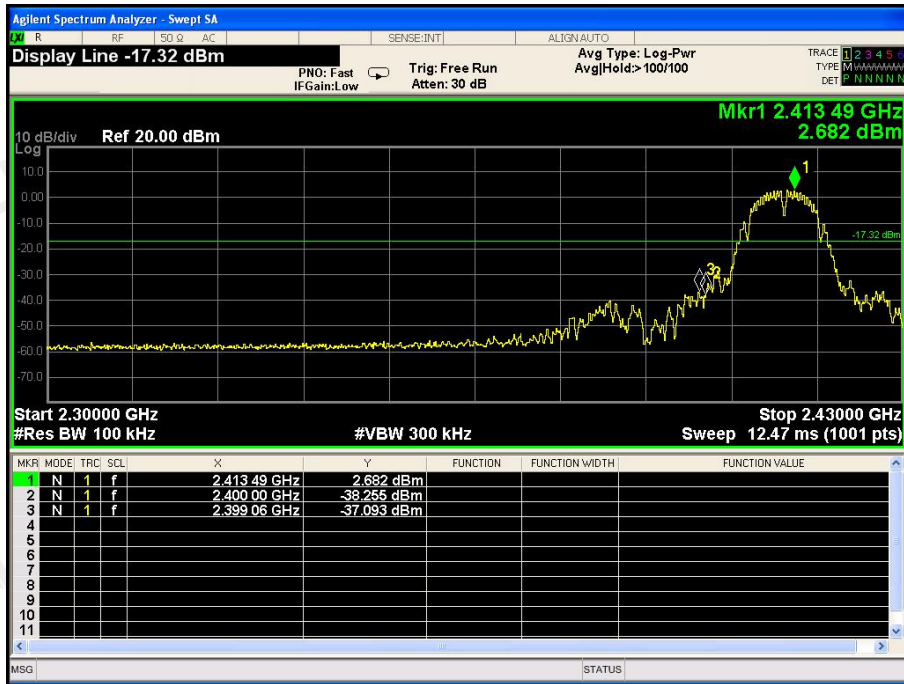

CH: 2462MHz



TX 802.11g Mode
CH: 2412MHz

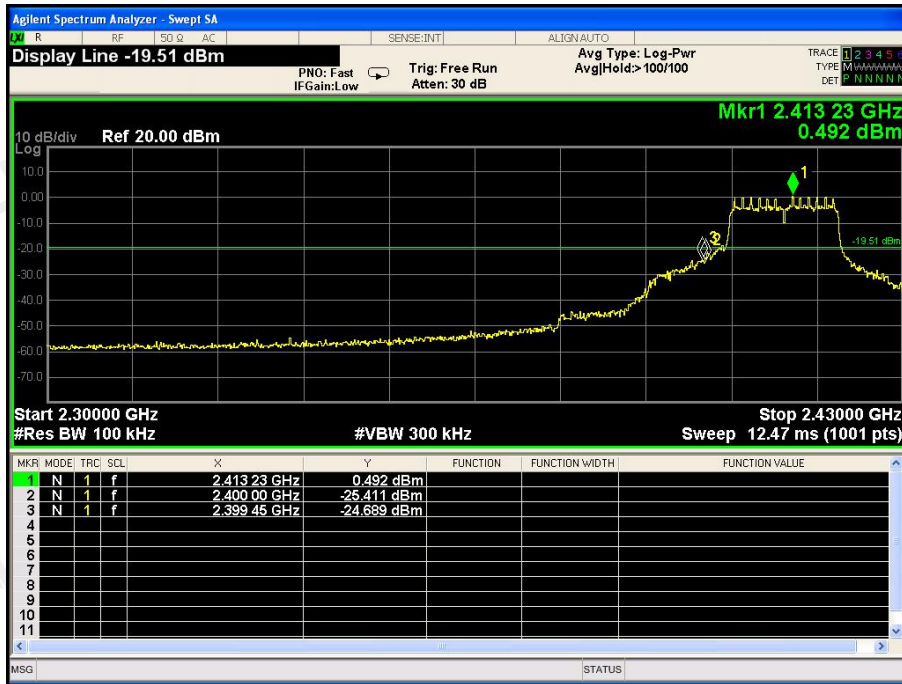

CH: 2462MHz



TX 802.11n/HT20 Mode
CH: 2412MHz

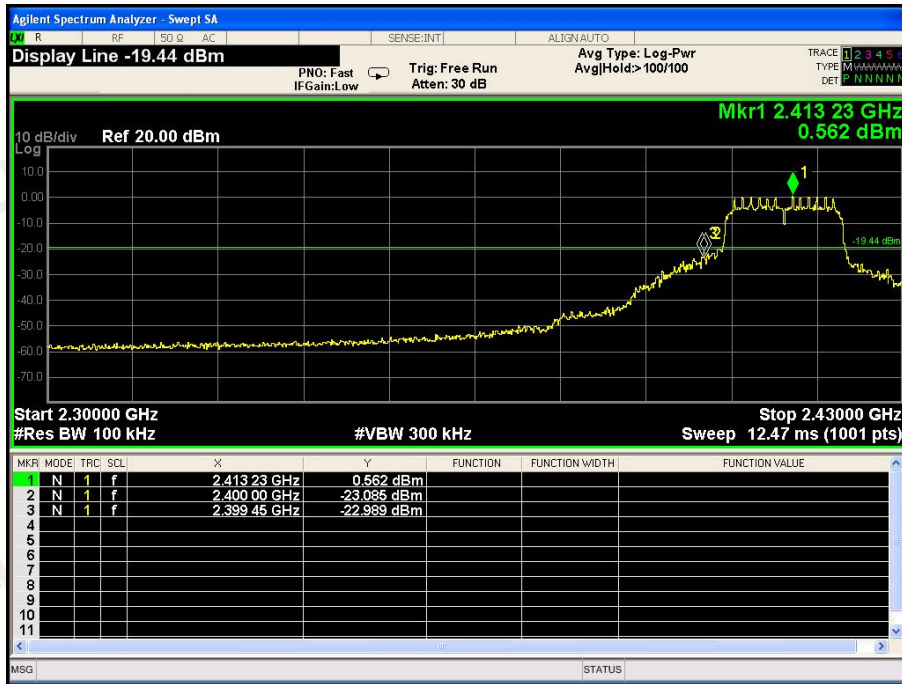

CH: 2462MHz



10 ANTENNA REQUIREMENT

Standard Applicable:

For intentional device, according to FCC 47 CFR Section 15.203, an intentional radiator shall be designed to ensure that no antenna other than that furnished by the responsible party shall be used with the device.

Antenna Connected Construction

The antenna used is a detachable antenna, using a reverse SMA connector (Provided by non-manufacturers will use the product can not work), considered a special connector accepted by the FCC to comply with rule part 15.203. Please see EUT photos for details, it comply with the standard requirement. The directional gains of antenna used for transmitting is 1dBi.

ANTENNA:

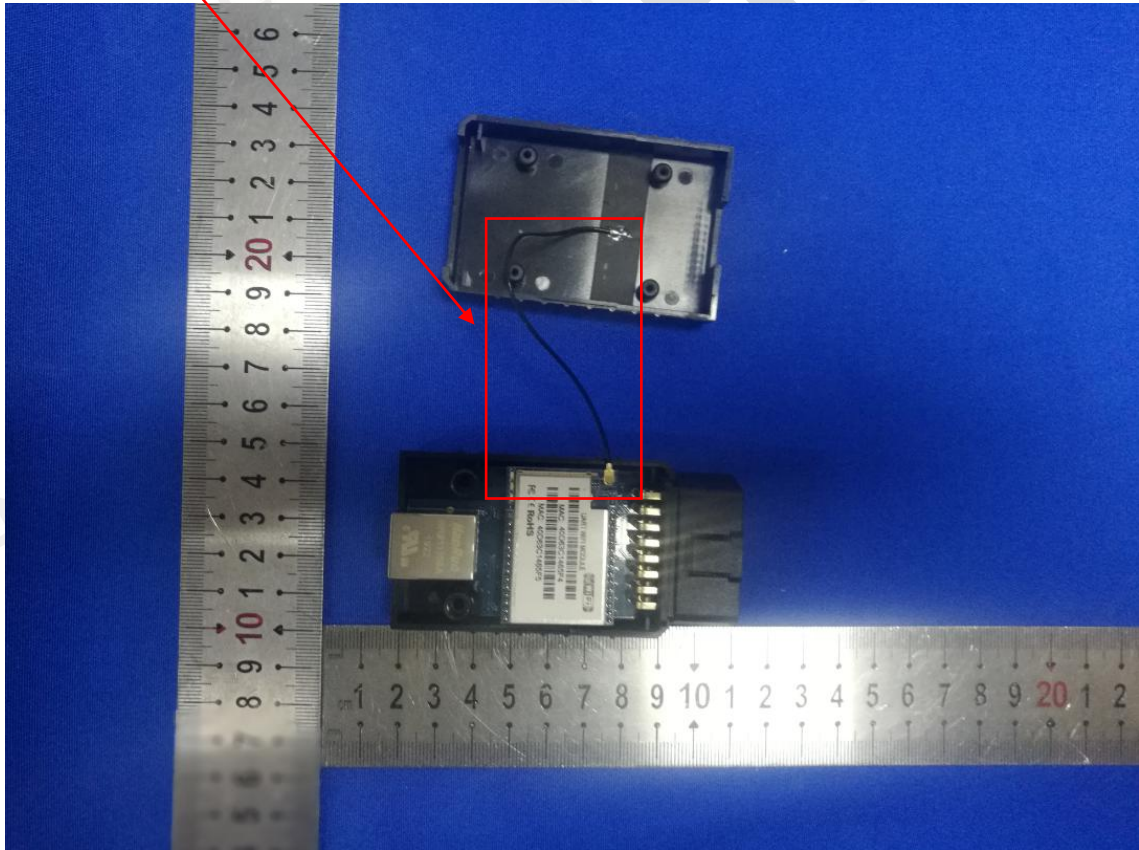

11 PHOTOGRAPH OF TEST

11.1 Radiated Emission





End of Report

DRAFT